

powermax380[®]

Plasma Arc Cutting System

***Operator Manual
803980 Revision 0***

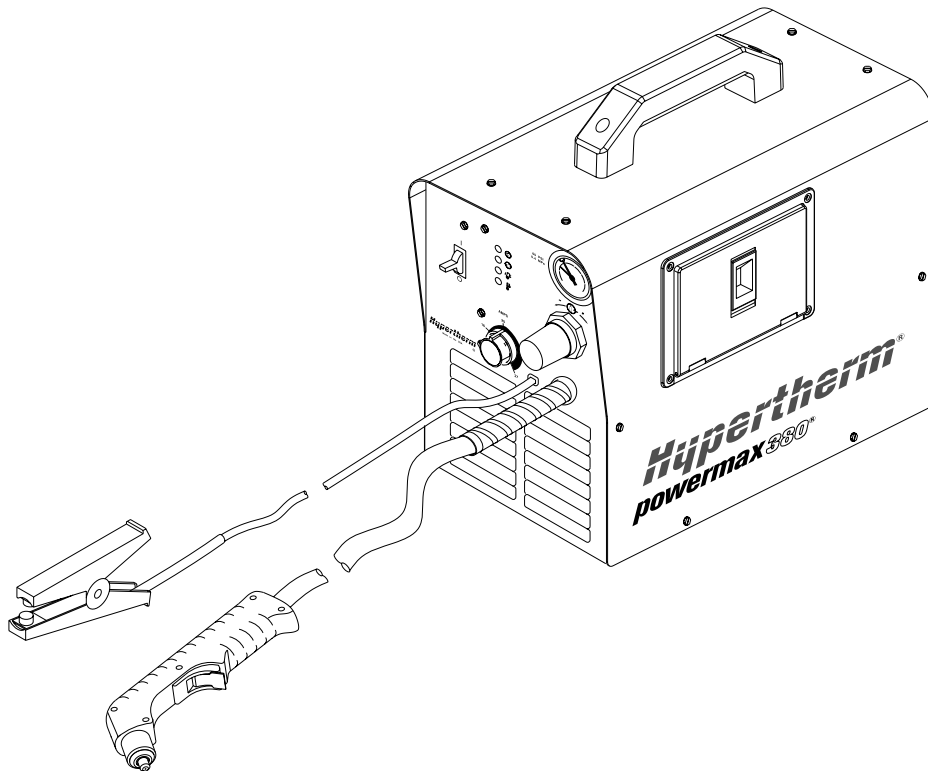

Hypertherm
*The world leader in
plasma cutting technology*

powermax380

Operator Manual

(P/N 803980)

Revision 0 – March 2001

**Hypertherm, Inc.
Hanover, NH USA
www.hypertherm.com
[email:info@hypertherm.com](mailto:info@hypertherm.com)**

**© Copyright 2001 Hypertherm, Inc.
All Rights Reserved**

**Hypertherm and Powermax are trademarks of Hypertherm, Inc.
and may be registered in the United States and/or other countries.**

Hypertherm®

*The world leader in
plasma cutting technology™*

Hypertherm, Inc.

Etna Road, P.O. Box 5010
Hanover, NH 03755 USA
603-643-3441 Tel (Main Office)
603-643-5352 Fax (All Departments)
800-643-9878 Tel (Technical Service)
800-737-2978 Tel (Customer Service)

Hypertherm Automation

5 Technology Drive, Suite 300
West Lebanon, NH 03784 USA
603-298-7970 Tel
603-298-7977 Fax

Hypertherm Plasmatechnik GmbH

Technologiepark Hanau
Rodenbacher Chaussee 6
D-63457 Hanau-Wolfgang, Germany
49 6181 58 2100 Tel
49 6181 58 2134 Fax
49 6181 58 2123 (Technical Service)

Hypertherm Singapore Pte Ltd

No. 19 Kaki Bukit Road 2
K.B. Warehouse Complex
Singapore 417847, Republic of Singapore
65 841 2489 Tel
65 841 2490 Fax
65 841 2489 (Technical Service)

Japan

Shinjuku Park Tower, 30th Floor
3-7-1 Nishi-Shinjuku, Shinjuku-ku, Tokyo,
163-1030, Japan
81 03 5326 3142 Tel
81 03 5326 3001 Fax

Hypertherm UK Ltd

9 Berkeley Court, Manor Park
Runcorn, Cheshire, England WA7 1TQ
44 1928 579 074 Tel
44 1928 579 604 Fax

France

15 Impasse des Rosiers
95610 Eragny, France
33 1 30 37 15 28 Tel
33 1 30 37 15 79 Fax

Hypertherm S.r.L.

Via Torino 2
20123 Milan, Italy
39 02 725 46 312 Tel
39 02 725 46 400 Fax
39 02 725 46 314 Tel (Technical Service)

Hypertherm B.V.

Burg. Haverkampstraat 13
7091 CN Dinxperlo, The Netherlands
31 315 655866 Tel
31 315 655886 Fax

Hypertherm B.V.

European Technical Service Organization (ETSO)
Edisonstraat 12
3281 NC Numansdorp, The Netherlands
00 800 49 73 7843 Toll Free in Europe
31 186 659494 Tel
31 186 659495 Fax

EMC INTRODUCTION

Hypertherm's CE-marked equipment is built in compliance with standard EN50199. The equipment should be installed and used in accordance with the information below to achieve electromagnetic compatibility.

The limits required by EN50199 may not be adequate to completely eliminate interference when the affected equipment is in close proximity or has a high degree of sensitivity. In such cases it may be necessary to use other measures to further reduce interference.

This plasma equipment is designed for use only in an industrial environment.

INSTALLATION AND USE

The user is responsible for installing and using the plasma equipment according to the manufacturer's instructions. If electromagnetic disturbances are detected then it shall be the responsibility of the user to resolve the situation with the technical assistance of the manufacturer. In some cases this remedial action may be as simple as earthing the cutting circuit, see *Earthing of Workpiece*. In other cases it could involve constructing an electromagnetic screen enclosing the power source and the work complete with associated input filters. In all cases electromagnetic disturbances must be reduced to the point where they are no longer troublesome.

ASSESSMENT OF AREA

Before installing the equipment the user shall make an assessment of potential electromagnetic problems in the surrounding area. The following shall be taken into account:

- a. Other supply cables, control cables, signalling and telephone cables; above, below and adjacent to the cutting equipment.
- b. Radio and television transmitters and receivers.
- c. Computer and other control equipment.
- d. Safety critical equipment, for example guarding of industrial equipment.
- e. Health of the people around, for example the use of pacemakers and hearing aids.
- f. Equipment used for calibration or measurement.
- g. Immunity of other equipment in the environment. User shall ensure that other equipment being used in the environment is compatible. This may require additional protection measures.
- h. Time of day that cutting or other activities are to be carried out.

The size of the surrounding area to be considered will depend on the structure of the building and other activities that are taking place. The surrounding area may extend beyond the boundaries of the premises.

METHODS OF REDUCING EMISSIONS

Mains Supply

Cutting equipment must be connected to the mains supply according to the manufacturer's recommendations. If interference occurs, it may be necessary to take additional precautions such as filtering of the mains supply. Consideration should be given to shielding the supply cable of permanently installed cutting equipment, in metallic conduit or equivalent. Shielding should be electrically continuous throughout its length. The shielding should be connected to the cutting mains supply so that good electrical contact is maintained between the conduit and the cutting power source enclosure.

Maintenance of Cutting Equipment

The cutting equipment must be routinely maintained according to the manufacturer's recommendations. All access and service doors and covers should be closed and properly fastened when the cutting equipment is in operation. The cutting equipment should not be modified in any way except for those changes and adjustments covered in the manufacturer's instructions. In particular, the spark gaps of arc striking and stabilizing devices should be adjusted and maintained according to the manufacturer's recommendations.

Cutting Cables

The cutting cables should be kept as short as possible and should be positioned close together, running at or close to the floor level.

Equipotential Bonding

Bonding of all metallic components in the cutting installation and adjacent to it should be considered. However, metallic components bonded to the workpiece will increase the risk that the operator could receive a shock by touching these metallic components and the electrode at the same time. The operator should be insulated from all such bonded metallic components.

Earthing of Workpiece

Where the workpiece is not bonded to earth for electrical safety, nor connected to earth because of its size and position, for example, ship's hull or building steelwork, a connection bonding the workpiece to earth may reduce emissions in some, but not all instances. Care should be taken to prevent the earthing of the workpiece increasing the risk of injury to users, or damage to other electrical equipment. Where necessary, the connection of the workpiece to earth should be made by a direct connection to the workpiece, but in some countries where direct connection is not permitted, the bonding should be achieved by suitable capacitances selected according to national regulations.

Note. The cutting circuit may or may not be earthed for safety reasons. Changing the earthing arrangements should only be authorized by a person who is competent to assess whether the changes will increase the risk of injury, for example, by allowing parallel cutting current return paths which may damage the earth circuits of other equipment. Further guidance is given in IEC TC26 (sec)94 and IEC TC26/108A/CD Arc Welding Equipment Installation and Use.

Screening and Shielding

Selective screening and shielding of other cables and equipment in the surrounding area may alleviate problems of interference. Screening of the entire plasma cutting installation may be considered for special applications.

WARRANTY

WARNING

Genuine Hypertherm parts are the factory-recommended replacement parts for your Hypertherm system. Any damage caused by the use of other than genuine Hypertherm parts may not be covered by the Hypertherm warranty.

WARNING

You are responsible for the safe use of the Product. Hypertherm does not and cannot make any guarantee or warranty regarding the safe use of the Product in your environment.

GENERAL

Hypertherm, Inc. warrants that its Products shall be free from defects in materials and workmanship, if Hypertherm is notified of a defect (i) with respect to the power supply within a period of two (2) years from the date of its delivery to you, and (ii) with respect to the torch and leads within a period of one (1) year from its date of delivery to you. This warranty shall not apply to any Product which has been incorrectly installed, modified, or otherwise damaged. Hypertherm, at its sole option, shall repair, replace, or adjust, free of charge, any defective Products covered by this warranty which shall be returned with Hypertherm's prior authorization (which shall not be unreasonably withheld), properly packed, to Hypertherm's place of business in Hanover, New Hampshire, or to an authorized Hypertherm repair facility, all costs, insurance and freight prepaid. Hypertherm shall not be liable for any repairs, replacement, or adjustments of Products covered by this warranty, except those made pursuant to this paragraph or with Hypertherm's prior written consent.

The warranty above is exclusive and is in lieu of all other warranties, express, implied, statutory, or otherwise with respect to the Products or as to the results which may be obtained therefrom, and all implied warranties or conditions of quality or of merchantability or fitness for a particular purpose or against infringement. The foregoing shall constitute the sole and exclusive remedy for any breach by Hypertherm of its warranty.

Distributors/OEMs may offer different or additional warranties, but Distributors/OEMs are not authorized to give any additional warranty protection to you or make any representation to you purporting to be binding upon Hypertherm.

PATENT INDEMNITY

Except only in cases of products not manufactured by Hypertherm or manufactured by a person other than Hypertherm not in strict conformity with Hypertherm's specifications and in cases of designs, processes, formulae, or combinations not developed or purported to be developed by Hypertherm, Hypertherm will defend or settle, at its own expense, any suit or proceeding brought against you alleging that the use of the Hypertherm product, alone and not in combination with any other product not supplied by Hypertherm, infringes any patent of any third party. You shall notify Hypertherm promptly upon learning of any action or

threatened action in connection with any such alleged infringement, and Hypertherm's obligation to indemnify shall be conditioned upon Hypertherm's sole control of, and the indemnified party's cooperation and assistance in, the defense of the claim.

LIMITATION OF LIABILITY

In no event shall Hypertherm be liable to any person or entity for any incidental, consequential, indirect, or punitive damages (including but not limited to lost profits) regardless of whether such liability is based on breach of contract, tort, strict liability, breach of warranties, failure of essential purpose or otherwise and even if advised of the possibility of such damages.

LIABILITY CAP

In no event shall Hypertherm's liability, whether such liability is based on breach of contract, tort, strict liability, breach of warranties, failure of essential purpose or otherwise, for any claim action suit or proceeding arising out of or relating to the use of the Products exceed in the aggregate the amount paid for the Products that gave rise to such claim.

INSURANCE

At all times you will have and maintain insurance in such quantities and types, and with coverage sufficient and appropriate to defend and to hold Hypertherm harmless in the event of any cause of action arising from the use of the Products.

NATIONAL AND LOCAL CODES

National and Local codes governing plumbing and electrical installation shall take precedent over any instructions contained in this manual. **In no event** shall Hypertherm be liable for injury to persons or property damage by reason of any code violation or poor work practices.

TRANSFER OF RIGHTS

You may transfer any remaining rights you may have hereunder only in connection with the sale of all or substantially all of your assets or capital stock to a successor in interest who agrees to be bound by all of the terms and conditions of this Warranty.

Electromagnetic Compatibility (EMC).....	i
General.....	ii
Patent Indemnity.....	ii
Warranty.....	ii
Disclaimer of Other Warranties.....	ii
National and Local Codes.....	ii
Upon Receipt.....	ii
Claims.....	ii
Section 1 – Safety	1-1
Recognize Safety Information.....	1-2
Follow Safety Instructions.....	1-2
Cutting Can Cause Fire or Explosion.....	1-2
Electric Shock Can Kill.....	1-3
Cutting Can Produce Toxic Fumes.....	1-3
A Plasma Arc Can Cause Injury and Burns.....	1-4
Arc Rays Can Burn Eyes and Skin.....	1-4
Grounding Safety.....	1-4
Compressed Gas Equipment Safety.....	1-5
Gas Cylinders Can Explode If Damaged.....	1-5
Noise Can Damage Hearing.....	1-5
Pacemaker and Hearing Aid Operation.....	1-5
A Plasma Arc Can Damage Frozen Pipes.....	1-5
Additional Safety Information.....	1-5
Warning Label.....	1-6
Section 1a – Sécurité	1a-1
Identifier les consignes de sécurité.....	1a-2
Suivre les instructions de sécurité.....	1a-2
Le coupage peut provoquer un incendie ou une explosion.....	1a-2
Les chocs électriques peuvent être fatals.....	1a-3
Le coupage peut produire des vapeurs toxiques.....	1a-3
L'arc plasma peut provoquer des blessures ou des brûlures.....	1a-4
Mise à la masse et à la terre.....	1a-4
Les rayons de l'arc peuvent brûler les yeux et la peau.....	1a-4
Sécurité des bouteilles de gaz comprimé.....	1a-5
Les bouteilles de gaz comprimé peuvent exploser en cas de dommages.....	1a-5
Le bruit peut provoquer des problèmes auditifs.....	1a-5
Pacemakers et prothèses auditives.....	1a-5
Étiquette de sécurité.....	1a-6
Section 2 – Specifications	2-1
Specifications – Power Supply.....	2-2
Specifications – PAC110T Torches.....	2-3
Symbols and Markings.....	2-4

TABLE OF CONTENTS

Section 3 – Installation	3-1
Upon Receipt	3-2
Contents of Box.....	3-2
Locating Power Supply	3-2
115/230 Voltage Configurations	3-2
Input Voltage Selector Switch	3-3
Power Cord Plugs	3-4
Grounding	3-4
Extension Cords.....	3-5
Work Cable and Clamp	3-5
Plasma Air Supply	3-6
Additional Air Filtration.....	3-6
Air Hose Connection	3-7
Section 4 – Operation	4-1
Controls and Indicators	4-2
Installing Torch Consumables	4-3
Turn On Power.....	4-4
Adjust Gas Pressure and Current Setting.....	4-4
Check Indicator Lights.....	4-5
Hand Torch Operation	4-6
Section 5 – Maintenance	5-1
Routine Maintenance	5-2
Inspect Consumables.....	5-3
Controls and Indicators	5-4
Basic Troubleshooting.....	5-5
Technical Questions	5-7
Parts	5-8
Torch Consumables.....	See Section 4
PAC110T Hand – Torch Assembly.....	5-9
Power Supply – Filter Regulator.....	5-10
Power Supply – Work Cable.....	5-10
Powermax380 Labels	5-11

Section 1

SAFETY

In this section:

Recognize Safety Information	1-2
Follow Safety Instructions	1-2
Cutting Can Cause Fire or Explosion	1-2
Electric Shock Can Kill	1-3
Cutting Can Produce Toxic Fumes	1-3
A Plasma Arc Can Cause Injury and Burns	1-4
Arc Rays Can Burn Eyes and Skin	1-4
Grounding Safety	1-4
Compressed Gas Equipment Safety	1-5
Gas Cylinders Can Explode If Damaged	1-5
Noise Can Damage Hearing	1-5
Pacemaker and Hearing Aid Operation	1-5
A Plasma Arc Can Damage Frozen Pipes	1-5
Additional Safety Information	1-5
Warning Label	1-6



RECOGNIZE SAFETY INFORMATION

The symbols shown in this section are used to identify potential hazards. When you see a safety symbol in this manual or on your machine, understand the potential for personal injury, and follow the related instructions to avoid the hazard.

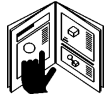

FOLLOW SAFETY INSTRUCTIONS

Read carefully all safety messages in this manual and safety labels on your machine.

- Keep the safety labels on your machine in good condition. Replace missing or damaged labels immediately.
- Learn how to operate the machine and how to use the controls properly. Do not let anyone operate it without instruction.

- Keep your machine in proper working condition. Unauthorized modifications to the machine may affect safety and machine service life.

DANGER WARNING CAUTION

A signal word DANGER or WARNING is used with a safety symbol. DANGER identifies the most serious hazards.

- DANGER and WARNING safety labels are located on your machine near specific hazards.
- WARNING safety messages precede related instructions in this manual that may result in injury or death if not followed correctly.
- CAUTION safety messages precede related instructions in this manual that may result in damage to equipment if not followed correctly.



CUTTING CAN CAUSE FIRE OR EXPLOSION

Fire Prevention

- Be sure the area is safe before doing any cutting. Keep a fire extinguisher nearby.
- Remove all flammables within 35 feet (10 m) of the cutting area.
- Quench hot metal or allow it to cool before handling or before letting it touch combustible materials.
- Never cut containers with potentially flammable materials inside – they must be emptied and properly cleaned first.
- Ventilate potentially flammable atmospheres before cutting.
- When cutting with oxygen as the plasma gas, an exhaust ventilation system is required.

Explosion Prevention

- Do not use the plasma system if explosive dust or vapors may be present.
- Do not cut pressurized cylinders, pipes, or any closed container.
- Do not cut containers that have held combustible materials.



WARNING

Explosion Hazard
Argon-Hydrogen and Methane

Hydrogen and methane are flammable gases that present an explosion hazard. Keep flames away from cylinders and hoses that contain methane or hydrogen mixtures. Keep flames and sparks away from the torch when using methane or argon-hydrogen plasma.



WARNING

Hydrogen Detonation with Aluminum Cutting

- When cutting aluminum underwater, or with the water touching the underside of the aluminum, free hydrogen gas may collect under the workpiece and detonate during plasma cutting operations.
- Install an aeration manifold on the floor of the water table to eliminate the possibility of hydrogen detonation. Refer to the Appendix section of this manual for aeration manifold details.



ELECTRIC SHOCK CAN KILL

Touching live electrical parts can cause a fatal shock or severe burn.

- Operating the plasma system completes an electrical circuit between the torch and the workpiece. The workpiece and anything touching the workpiece are part of the electrical circuit.
- Never touch the torch body, workpiece or the water in a water table when the plasma system is operating.

Electric Shock Prevention

All Hypertherm plasma systems use high voltage in the cutting process (200 to 400 VDC are common). Take the following precautions when operating this system:

- Wear insulated gloves and boots, and keep your body and clothing dry.
- Do not stand, sit or lie on – or touch – any wet surface when using the plasma system.
- Insulate yourself from work and ground using dry insulating mats or covers big enough to prevent any physical contact with the work or ground. If you must work in or near a damp area, use extreme caution.
- Provide a disconnect switch close to the power supply with properly sized fuses. This switch allows the operator to turn off the power supply quickly in an emergency situation.
- When using a water table, be sure that it is correctly connected to earth ground.

- Install and ground this equipment according to the instruction manual and in accordance with national and local codes.
- Inspect the input power cord frequently for damage or cracking of the cover. Replace a damaged power cord immediately. **Bare wiring can kill.**
- Inspect and replace any worn or damaged torch leads.
- Do not pick up the workpiece, including the waste cutoff, while you cut. Leave the workpiece in place or on the workbench with the work cable attached during the cutting process.
- Before checking, cleaning or changing torch parts, disconnect the main power or unplug the power supply.
- Never bypass or shortcut the safety interlocks.
- Before removing any power supply or system enclosure cover, disconnect electrical input power. Wait 5 minutes after disconnecting the main power to allow capacitors to discharge.
- Never operate the plasma system unless the power supply covers are in place. Exposed power supply connections present a severe electrical hazard.
- When making input connections, attach proper grounding conductor first.
- Each Hypertherm plasma system is designed to be used only with specific Hypertherm torches. Do not substitute other torches which could overheat and present a safety hazard.



CUTTING CAN PRODUCE TOXIC FUMES

Cutting can produce toxic fumes and gases that deplete oxygen and cause injury or death.

- Keep the cutting area well ventilated or use an approved air-supplied respirator.
- Do not cut in locations near degreasing, cleaning or spraying operations. The vapors from certain chlorinated solvents decompose to form phosgene gas when exposed to ultraviolet radiation.
- Do not cut metal coated or containing toxic materials, such as zinc (galvanized), lead, cadmium or beryllium, unless the area is well ventilated and the operator wears an air-supplied respirator. The coatings and any metals containing these elements can produce toxic fumes when cut.
- Never cut containers with potentially toxic materials inside – they must be emptied and properly cleaned first.
- This product, when used for welding or cutting, produces fumes or gases which contain chemicals known to the State of California to cause birth defects and, in some cases, cancer.

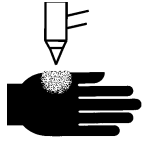

A PLASMA ARC CAN CAUSE INJURY AND BURNS

Instant-On Torches

Plasma arc comes on immediately when the torch switch is activated.

The plasma arc will cut quickly through gloves and skin.

- Keep away from the torch tip.
- Do not hold metal near the cutting path.
- Never point the torch toward yourself or others.



ARC RAYS CAN BURN EYES AND SKIN

Eye Protection Plasma arc rays produce intense visible and invisible (ultraviolet and infrared) rays that can burn eyes and skin.

- Use eye protection in accordance with applicable national or local codes.
- Wear eye protection (safety glasses or goggles with side shields, or a welding helmet) with appropriate lens shading to protect your eyes from the arc's ultraviolet and infrared rays.

Skin Protection Wear protective clothing to protect against burns caused by ultraviolet light, sparks and hot metal.

- Gauntlet gloves, safety shoes and hat.
- Flame-retardant clothing to cover all exposed areas.
- Cuffless trousers to prevent entry of sparks and slag.
- Remove any combustibles, such as a butane lighter or matches, from your pockets before cutting.

Arc Current
 Up to 100 A
 100-200 A
 200-400 A
 Over 400 A



Lens Shade	
AWS (USA)	ISO 4850
No. 8	No. 11
No. 10	No. 11-12
No. 12	No. 13
No. 14	No. 14

Cutting Area Prepare the cutting area to reduce reflection and transmission of ultraviolet light:

- Paint walls and other surfaces with dark colors to reduce reflection.
- Use protective screens or barriers to protect others from flash and glare.
- Warn others not to watch the arc. Use placards or signs.



GROUNDING SAFETY

Work Cable Attach the work cable securely to the workpiece or the work table with good metal-to-metal contact. Do not connect it to the piece that will fall away when the cut is complete.

Work Table Connect the work table to an earth ground, in accordance with appropriate national or local electrical codes.

Input Power

- Be sure to connect the power cord ground wire to the ground in the disconnect box.
- If installation of the plasma system involves connecting the power cord to the power supply, be sure to connect the power cord ground wire properly.
- Place the power cord's ground wire on the stud first, then place any other ground wires on top of the power cord ground. Fasten the retaining nut tightly.
- Tighten all electrical connections to avoid excessive heating.

COMPRESSED GAS EQUIPMENT SAFETY

- Never lubricate cylinder valves or regulators with oil or grease.
- Use only correct gas cylinders, regulators, hoses and fittings designed for the specific application.
- Maintain all compressed gas equipment and associated parts in good condition.
- Label and color-code all gas hoses to identify the type of gas in each hose. Consult applicable national or local codes.

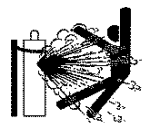
**GAS CYLINDERS CAN EXPLODE IF DAMAGED**

Gas cylinders contain gas under high pressure. If damaged, a cylinder can explode.

- Handle and use compressed gas cylinders in accordance with applicable national or local codes.
- Never use a cylinder that is not upright and secured in place.
- Keep the protective cap in place over valve except when the cylinder is in use or connected for use.
- Never allow electrical contact between the plasma arc and a cylinder.
- Never expose cylinders to excessive heat, sparks, slag or open flame.
- Never use a hammer, wrench or other tool to open a stuck cylinder valve.

**NOISE CAN DAMAGE HEARING**

Prolonged exposure to noise from cutting or gouging can damage hearing.

- Use approved ear protection when using plasma system.
- Warn others nearby about the noise hazard.

**PACEMAKER AND HEARING AID OPERATION**

Pacemaker and hearing aid operation can be affected by magnetic fields from high currents.

Pacemaker and hearing aid wearers should consult a doctor before going near any plasma arc cutting and gouging operations.

To reduce magnetic field hazards:

- Keep both the work cable and the torch lead to one side, away from your body.
- Route the torch leads as close as possible to the work cable.
- Do not wrap or drape the torch lead or work cable around your body.
- Keep as far away from the power supply as possible.

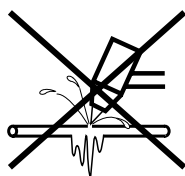
**A PLASMA ARC CAN DAMAGE FROZEN PIPES**

Frozen pipes may be damaged or can burst if you attempt to thaw them with a plasma torch.

ADDITIONAL SAFETY INFORMATION

1. ANSI Standard Z49.1, *Safety in Welding and Cutting*, American Welding Society, 550 LeJeune Road P.O. Box 351020, Miami, FL 33135
2. ANSI Standard Z49.2, *Fire Prevention in the Use of Cutting and Welding Processes*, American National Standards Institute 1430 Broadway, New York, NY 10018
3. ANSI Standard Z87.1, *Safe Practices for Occupation and Educational Eye and Face Protection*, American National Standards Institute, 1430 Broadway, New York, NY 10018
4. AWS F4.1, *Recommended Safe Practices for the Preparation for Welding and Cutting of Containers and Piping That Have Held Hazardous Substances*, American Welding Society 550 LeJeune Road, P.O. Box 351040, Miami, FL 33135
5. AWS F5.2, *Recommended Safe Practices for Plasma Arc Cutting*, American Welding Society 550 LeJeune Road, P.O. Box 351040, Miami, FL 33135
6. CGA Pamphlet P-1, *Safe Handling of Compressed Gases in Cylinders*, Compressed Gas Association 1235 Jefferson Davis Highway, Arlington, VA 22202
7. CSA Standard W117.2, *Code for Safety in Welding and Cutting*, Canadian Standards Association Standard Sales 178 Rexdale Boulevard, Rexdale, Ontario M9W 1R3, Canada
8. NFPA Standard 51B, *Cutting and Welding Processes*, National Fire Protection Association 470 Atlantic Avenue, Boston, MA 02210
9. NFPA Standard 70-1978, *National Electrical Code*, National Fire Protection Association, 470 Atlantic Avenue, Boston, MA 02210
10. OSHA, *Safety and Health Standards*, 29FR 1910 U.S. Government Printing Office, Washington, D.C. 20402

SAFETY

WARNING LABEL

This warning label is affixed to some power supplies. It is important that the operator and maintenance technician understand the intent of these warning symbols as described. The numbered text corresponds to the numbered boxes on the label.

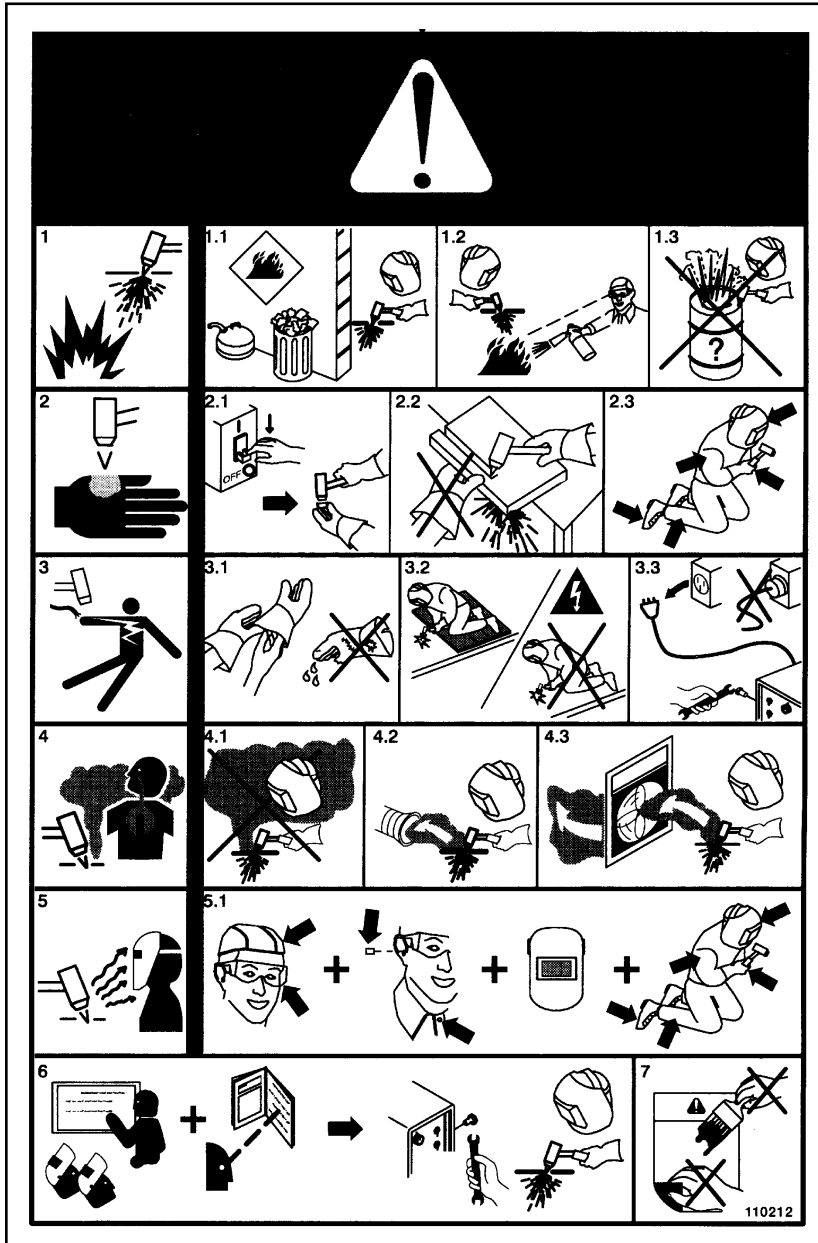

1. Cutting sparks can cause explosion or fire.
 - 1.1 Keep flammables away from cutting.
 - 1.2 Keep a fire extinguisher nearby, and have a watchperson ready to use it.
 - 1.3 Do not cut on any closed containers.
2. The plasma arc can cause injury and burns.
 - 2.1 Turn off power before disassembling torch.
 - 2.2 Do not hold the material near cutting path.
 - 2.3 Wear complete body protection.
3. Electric shock from torch or wiring can kill. Protect yourself from electric shock.
 - 3.1 Wear insulating gloves. Do not wear wet or damaged gloves.
 - 3.2 Insulate yourself from work and ground.
 - 3.3 Disconnect input plug or power before working on machine.
4. Breathing cutting fumes can be hazardous to your health.
 - 4.1 Keep your head out of the fumes.
 - 4.2 Use forced ventilation or local exhaust to remove the fumes.
 - 4.3 Use ventilating fan to remove the fumes.
5. Arc rays can burn eyes and injure skin.
 - 5.1 Wear hat and safety glasses. Use ear protection and button shirt collar. Use welding helmet with correct shade of filter. Wear complete body protection.
6. Become trained and read the instructions before working on the machine or cutting.
7. Do not remove or paint over (cover) warning labels.

Section 1a

SÉCURITÉ

Cette section comprend:

IDENTIFIER LES CONSIGNES DE SÉCURITÉ	1a-2
SUIVRE LES INSTRUCTIONS DE SÉCURITÉ	1a-2
LE COUPAGE PEUT PROVOQUER UN INCENDIE OU UNE EXPLOSION ..	1a-2
LES CHOCS ÉLECTRIQUES PEUVENT ÊTRE FATALS	1a-3
LE COUPAGE PEUT PRODUIRE DES VAPEURS TOXIQUES	1a-3
L'ARC PLASMA PEUT PROVOQUER DES BLESSURES OU DES BRÛLURES	1a-4
LES RAYONS DE L'ARC PEUVENT BRÛLER LES YEUX ET LA PEAU	1a-4
MISE À LA MASSE ET À LA TERRE	1a-4
SÉCURITÉ DES BOUTEILLES DE GAZ COMPRIMÉ	1a-5
LES BOUTEILLES DE GAZ COMPRIMÉ PEUVENT EXPLOSER EN CAS DE DOMMAGES	1a-5
LE BRUIT PEUT PROVOQUER DES PROBLÈMES AUDITIFS	1a-5
PACEMAKERS ET PROTHÈSES AUDITIVES	1a-5
ÉTIQUETTE DE SÉCURITÉ	1a-6

**IDENTIFIER LES CONSIGNES DE SÉCURITÉ**

Les symboles indiqués dans cette section sont utilisés pour identifier les risques éventuels. Si vous trouvez un symbole de sécurité, que ce soit dans ce manuel ou sur l'équipement, soyez conscient des risques de blessures et suivez les instructions correspondantes afin d'éviter ces risques.

**SUIVRE LES INSTRUCTIONS DE SÉCURITÉ**

Lire attentivement toutes les consignes de sécurité dans le présent manuel et sur les étiquettes de sécurité se trouvant sur la machine.

- Les étiquettes de sécurité doivent rester lisibles. Remplacer immédiatement les étiquettes manquantes ou abîmées.
- Apprendre à faire fonctionner la machine et à utiliser correctement les commandes. Ne laisser personne utiliser la machine sans connaître son fonctionnement.

- Garder la machine en bon état. Des modifications non autorisées sur la machine peuvent engendrer des problèmes de sécurité et raccourcir la durée d'utilisation de l'équipement.

DANGER AVERTISSEMENT PRÉCAUTION

Les signaux DANGER ou AVERTISSEMENT sont utilisés avec un symbole de sécurité, DANGER correspondant aux risques les plus sérieux.

- Les étiquettes de sécurité DANGER et AVERTISSEMENT sont situées sur la machine pour signaler certains dangers spécifiques.
- Les messages d'AVERTISSEMENT précèdent les instructions d'utilisation expliquées dans ce manuel et signalent les risques de blessures ou de mort au cas où ces instructions ne seraient pas suivies correctement.
- Les messages de PRÉCAUTION précèdent les instructions d'utilisation contenues dans ce manuel et signalent que le matériel risque d'être endommagé si les instructions ne sont pas suivies correctement.

**LE COUPAGE PEUT PROVOQUER UN INCENDIE OU UNE EXPLOSION****Prévention des incendies**

- Avant de commencer, s'assurer que la zone de coupage ne présente aucun danger. Conserver un extincteur à proximité.
- Éloigner toute matière inflammable à une distance d'au moins 10 m du poste de coupage.
- Tremper le métal chaud ou le laisser refroidir avant de le manipuler ou avant de le mettre en contact avec des matériaux combustibles.
- Ne jamais couper des récipients pouvant contenir des matières inflammables avant de les avoir vidés et nettoyés correctement.
- Aérer toute atmosphère potentiellement inflammable avant d'utiliser un système plasma.
- Lors de l'utilisation d'oxygène comme gaz plasma, un système de ventilation par aspiration est nécessaire.

Prévention des explosions

- Ne pas couper en présence de poussière ou de vapeurs.
- Ne pas couper de bouteilles, de tuyaux ou autres récipients fermés et pressurisés.
- Ne pas couper de récipients contenant des matières combustibles.

**AVERTISSEMENT**

Risque d'explosion
Argon-hydrogène et méthane

L'hydrogène et le méthane sont des gaz inflammables et potentiellement explosifs. Conserver à l'écart de toute flamme les bouteilles et tuyaux contenant des mélanges à base d'hydrogène ou de méthane. Maintenir toute flamme et étincelle à l'écart de la torche lors de l'utilisation d'un plasma d'argon-hydrogène ou de méthane.

**AVERTISSEMENT**

Détonation de l'hydrogène lors du coupage de l'aluminium

- Lors du coupage de l'aluminium sous l'eau, ou si l'eau touche la partie inférieure de la pièce d'aluminium, de l'hydrogène libre peut s'accumuler sous la pièce à couper et détonner lors du coupage plasma.
- Installer un collecteur d'aération au fond de la table à eau afin d'éliminer les risques de détonation de l'hydrogène. Se référer à l'annexe du manuel pour plus de renseignements sur les collecteurs d'aération.



LES CHOCS ÉLECTRIQUES PEUVENT ÊTRE FATALS

Toucher une pièce électrique sous tension peut provoquer un choc électrique fatal ou des brûlures graves.

- La mise en fonctionnement du système plasma ferme un circuit électrique entre la torche et la pièce à couper. La pièce à couper et tout autre élément en contact avec cette pièce font partie du circuit électrique.
- Ne jamais toucher le corps de la torche, la pièce à couper ou l'eau de la table à eau pendant le fonctionnement du système plasma.

Prévention des chocs électriques

Tous les systèmes plasma Hypertherm utilisent des hautes tensions pour le coupage (souvent de 200 à 400 V). On doit prendre les précautions suivantes quand on utilise le système plasma :

- Porter des bottes et des gants isolants et garder le corps et les vêtements au sec.
- Ne pas se tenir, s'asseoir ou se coucher sur une surface mouillée, ni la toucher quand on utilise le système plasma.
- S'isoler de la surface de travail et du sol en utilisant des tapis isolants secs ou des couvertures assez grandes pour éviter tout contact physique avec le travail ou le sol. S'il s'avère nécessaire de travailler dans ou près d'un endroit humide, procéder avec une extrême prudence.
- Installer un sectionneur avec fusibles appropriés, à proximité de la source de courant. Ce dispositif permet à l'opérateur d'arrêter rapidement la source de courant en cas d'urgence.
- En cas d'utilisation d'une table à eau, s'assurer que cette dernière est correctement mise à la terre.
- Installer et mettre à la terre l'équipement selon les instructions du présent manuel et conformément aux codes électriques locaux et nationaux.
- Inspecter fréquemment le cordon d'alimentation primaire pour s'assurer qu'il n'est ni endommagé, ni fendu. Remplacer immédiatement un cordon endommagé. **Un câble dénudé peut tuer.**
- Inspecter et remplacer les câbles de la torche qui sont usés ou endommagés.
- Ne pas saisir la pièce à couper ni les chutes lors du coupage. Laisser la pièce à couper en place ou sur la table de travail, le câble de retour connecté lors du coupage.
- Avant de vérifier, de nettoyer ou de remplacer les pièces de la torche, couper l'alimentation ou débrancher la prise de courant.
- Ne jamais contourner ou court-circuiter les verrouillages de sécurité.
- Avant d'enlever le capot du système ou de la source de courant, couper l'alimentation électrique. Attendre ensuite 5 minutes pour que les condensateurs se déchargent.
- Ne jamais faire fonctionner le système plasma sans que les capots de la source de courant ne soient en place. Les raccords exposés de la source de courant sont extrêmement dangereux.
- Lors de l'installation des connexions, attacher tout d'abord la prise de terre appropriée.
- Chaque système plasma Hypertherm est conçu pour être utilisé uniquement avec des torches Hypertherm spécifiques. Ne pas utiliser des torches inappropriées qui pourraient surchauffer et présenter des risques pour la sécurité.



LE COUPAGE PEUT PRODUIRE DES VAPEURS TOXIQUES

Le coupage peut produire des vapeurs et des gaz toxiques qui réduisent le niveau d'oxygène dans l'air et peuvent provoquer des blessures, voire la mort.

- Conserver le poste de coupage bien aéré ou utiliser un masque respiratoire homologué.
- Ne pas procéder au coupage près d'endroits où s'effectuent le dégraissage, le nettoyage ou la vaporisation. Certains solvants chlorés se décomposent sous l'effet des rayons ultraviolets et forment du phosgène.
- Ne pas couper des métaux peints ou contenant des matières toxiques comme le zinc (galvanisé), le plomb, le cadmium ou le béryllium, à moins que la zone de travail soit très bien ventilée et que l'opérateur porte un masque respiratoire. Les revêtements et métaux contenant ces matières peuvent produire des vapeurs toxiques lors du coupage.
- Ne jamais couper de récipients pouvant contenir des matières inflammables avant de les avoir vidés et nettoyés correctement.
- Quand on utilise ce produit pour le soudage ou le coupage, il dégage des fumées et des gaz qui contiennent des produits chimiques qui, selon l'état de Californie, provoquent des anomalies congénitales et, dans certains cas, le cancer.



L'ARC PLASMA PEUT PROVOQUER DES BLESSURES OU DES BRÛLURES

Torches à allumage instantané

L'arc plasma s'allume immédiatement après que la torche soit mise en marche.

L'arc plasma coupe facilement les gants et la peau.

- Rester éloigné de l'extrémité de la torche.
- Ne pas tenir de métal près de la trajectoire de coupe.
- Ne jamais pointer la torche vers soi ou d'autres personnes.



LES RAYONS DE L'ARC PEUVENT BRÛLER LES YEUX ET LA PEAU

Protection des yeux Les rayons de l'arc plasma produisent de puissants rayons visibles ou invisibles (ultraviolets et infrarouges) qui peuvent brûler les yeux et la peau.

- Utiliser des lunettes de sécurité conformément aux codes locaux ou nationaux en vigueur.
- Porter des lunettes de protection (lunettes ou masque muni d'écrans latéraux ou encore masque de soudure) avec des verres teintés appropriés pour protéger les yeux des rayons ultraviolets et infrarouges de l'arc.

- Gants à crispin, chaussures et casque de sécurité.
- Vêtements ignifuges couvrant toutes les parties exposées du corps.
- Pantalon sans revers pour éviter que des étincelles ou des scories puissent s'y loger.
- Avant le coupage, retirer de ses poches tout objet combustible comme les briquets au butane ou les allumettes.

Zone de coupage Préparer la zone de coupage afin de réduire la réverbération et la transmission de la lumière ultraviolette :

- Peindre les murs et autres surfaces de couleur sombre pour réduire la réflexion de la lumière.
- Utiliser des écrans et autres dispositifs de protection afin de protéger les autres personnes de la lumière et de la réverbération.
- Prévenir les autres personnes de ne pas regarder l'arc. Utiliser des affiches ou des panneaux.

Courant de l'arc	Puissance des verres teintés	
	AWS (É.-U.)	ISO 4850
Jusqu'à 100 A	N° 8	N° 11
100-200 A	N° 10	N° 11-12
200-400 A	N° 12	N° 13
Plus de 400 A	N° 14	N° 14

Protection de la peau Porter des vêtements de sécurité pour se protéger contre les brûlures que peuvent causer les rayons ultraviolets, les étincelles et le métal brûlant :



MISE À LA MASSE ET À LA TERRE

Câble de retour Bien fixer le câble de retour (ou de masse) à la pièce à couper ou à la table de travail de façon à assurer un bon contact métal-métal. Ne pas fixer le câble de retour à la partie de la pièce qui doit se détacher.

Table de travail Raccorder la table de travail à la terre, conformément aux codes de sécurité locaux ou nationaux appropriés.

Alimentation

- S'assurer que le fil de terre du cordon d'alimentation est connecté à la terre dans le coffret du sectionneur.
- S'il est nécessaire de brancher le cordon d'alimentation à la source de courant lors de l'installation du système, s'assurer que le fil de terre est correctement branché.
- Placer tout d'abord le fil de terre du cordon d'alimentation sur le plot de mise à la terre puis placer les autres fils de terre par-dessus. Bien serrer l'écrou de retenue.
- S'assurer que toutes les connexions sont bien serrées pour éviter la surchauffe.

SÉCURITÉ DES BOUTEILLES DE GAZ COMPRIMÉ

- Ne jamais lubrifier les robinets des bouteilles ou les régulateurs avec de l'huile ou de la graisse.
- Utiliser uniquement les bouteilles, régulateurs, tuyaux et accessoires appropriés et conçus pour chaque application spécifique.
- Entretenir l'équipement et les pièces d'équipement à gaz comprimé afin de les garder en bon état.
- Étiqueter et coder avec des couleurs tous les tuyaux de gaz afin d'identifier le type de gaz contenu dans chaque tuyau. Se référer aux codes locaux ou nationaux en vigueur.



LES BOUTEILLES DE GAZ COMPRIMÉ PEUVENT EXPLOSER EN CAS DE DOMMAGES

Les bouteilles de gaz contiennent du gaz à haute pression. Si une bouteille est endommagée, elle peut exploser.

- Manipuler et utiliser les bouteilles de gaz comprimé conformément aux codes locaux ou nationaux.
- Ne jamais utiliser une bouteille qui n'est pas placée à la verticale et bien assujettie.
- Le capuchon de protection doit être placé sur le robinet sauf si la bouteille est en cours d'utilisation ou connectée pour utilisation.
- Éviter à tout prix le contact électrique entre l'arc plasma et une bouteille.
- Ne jamais exposer des bouteilles à une chaleur excessive, aux étincelles, aux scories ou aux flammes nues.
- Ne jamais utiliser des marteaux, des clés ou d'autres outils pour débloquer le robinet des bouteilles.



LE BRUIT PEUT PROVOQUER DES PROBLÈMES AUDITIFS

Une exposition prolongée au bruit du coupage ou du gougeage peut provoquer des problèmes auditifs.

- Utiliser un casque de protection homologué lors de l'utilisation du système plasma.
- Prévenir les personnes aux alentours des risques encourus en cas d'exposition au bruit.



PACEMAKERS ET PROTHÈSES AUDITIVES

Les champs magnétiques produits par les courants à haute tension peuvent affecter le fonctionnement des prothèses auditives et des pacemakers. Les personnes portant ce type d'appareil doivent consulter un médecin avant de s'approcher d'un lieu où s'effectue le coupage ou le gougeage plasma.

Pour réduire les risques associés aux champs magnétiques :

- Garder loin de soi et du même côté du corps le câble de retour et le faisceau de la torche.
- Faire passer le faisceau de la torche le plus près possible du câble de retour.
- Ne pas s'enrouler le faisceau de la torche ou le câble de retour autour du corps.
- Se tenir le plus loin possible de la source de courant.

Étiquette de sécurité

Cette étiquette est apposée sur certaines sources de courant. Il est important que l'utilisateur et le technicien de maintenance comprennent la signification des symboles de sécurité. Les numéros de la liste correspondent aux numéros des images.



1. Les étincelles produites par le coupage peuvent provoquer une explosion ou un incendie.
 - 1.1 Pendant le coupage, éloigner toute matière inflammable.
 - 1.2 Conserver un extincteur à proximité et s'assurer qu'une personne soit prête à l'utiliser.
 - 1.3 Ne jamais couper de récipients fermés.
2. L'arc plasma peut provoquer des blessures et des brûlures.
 - 2.1 Couper l'alimentation avant de démonter la torche.
 - 2.2 Ne pas tenir la surface à couper près de la trajectoire de coupe.
 - 2.3 Porter des vêtements de protection couvrant tout le corps.
3. Un choc électrique causé par la torche ou les câbles peut être fatal. Se protéger contre les risques de chocs électriques.
 - 3.1 Porter des gants isolants. Ne pas porter de gants mouillés ou abîmés.
 - 3.2 S'isoler de la surface de travail et du sol.
 - 3.3 Débrancher la prise ou la source de courant avant de manipuler l'équipement.
4. L'inhalation des vapeurs produites par le coupage peut être dangereuse pour la santé.
 - 4.1 Garder le visage à l'écart des vapeurs.
 - 4.2 Utiliser un système de ventilation par aspiration ou d'échappement localisé pour dissiper les vapeurs.
 - 4.3 Utiliser un ventilateur pour dissiper les vapeurs.
5. Les rayons de l'arc peuvent brûler les yeux et provoquer des lésions de la peau.
 - 5.1 Porter un casque et des lunettes de sécurité. Se protéger les oreilles et porter une chemise dont le col peut être déboutonné. Porter un casque de soudure dont la protection filtrante est suffisante. Porter des vêtements protecteurs couvrant la totalité du corps.
6. Se former à la technique du coupage et lire les instructions avant de manipuler l'équipement ou de procéder au coupage.
7. Ne pas retirer ou peindre (recouvrir) les étiquettes de sécurité.

Section 2

SPECIFICATIONS

In this section:

Specifications – Power Supply	2-2
Specifications – PAC110T Torches	2-3
Symbols and Markings.....	2-4

SPECIFICATIONS

Specifications – Power Supply

Rated Open Circuit Voltage (U_0)	288 VDC	
Rated Output Current (I_2)	14 A – 27 A	
Rated Output Voltage (U_2)	91 VDC	
Duty Cycle at 40°C (See data plate on power supply for more information on duty cycle.)	35 % ($I_2=27$ A, $U_2=91$ V) 60 % ($I_2=21$ A, $U_2=88$ V) 100 % ($I_2=17$ A, $U_2=87$ V)	
Operating Temperature	-4° to 104° F (-20° to 40°C)	
Storage Temperature	-58° to 131° F (-50° to 55°C)	
Power Factor	0.975	
Rated Pilot Current	12 A	
Input Voltage (U_1)/ Input Current (I_1) at Rated Output ($U_{2\text{ MAX}}$, $I_{2\text{ MAX}}$)	115 V / 28 A 230 V / 14 A	
Gas Type	Air	Nitrogen
Gas Quality	Clean, dry, oil-free	99.995 % pure
Gas Inlet Pressure and Flow	See <i>Setup</i> , Section 3	

Powermax380 Power Supply Dimensions and Weight

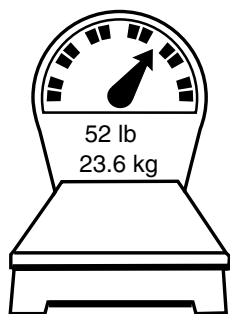

Weight includes hand torch and 20 ft (6.1 m) lead.

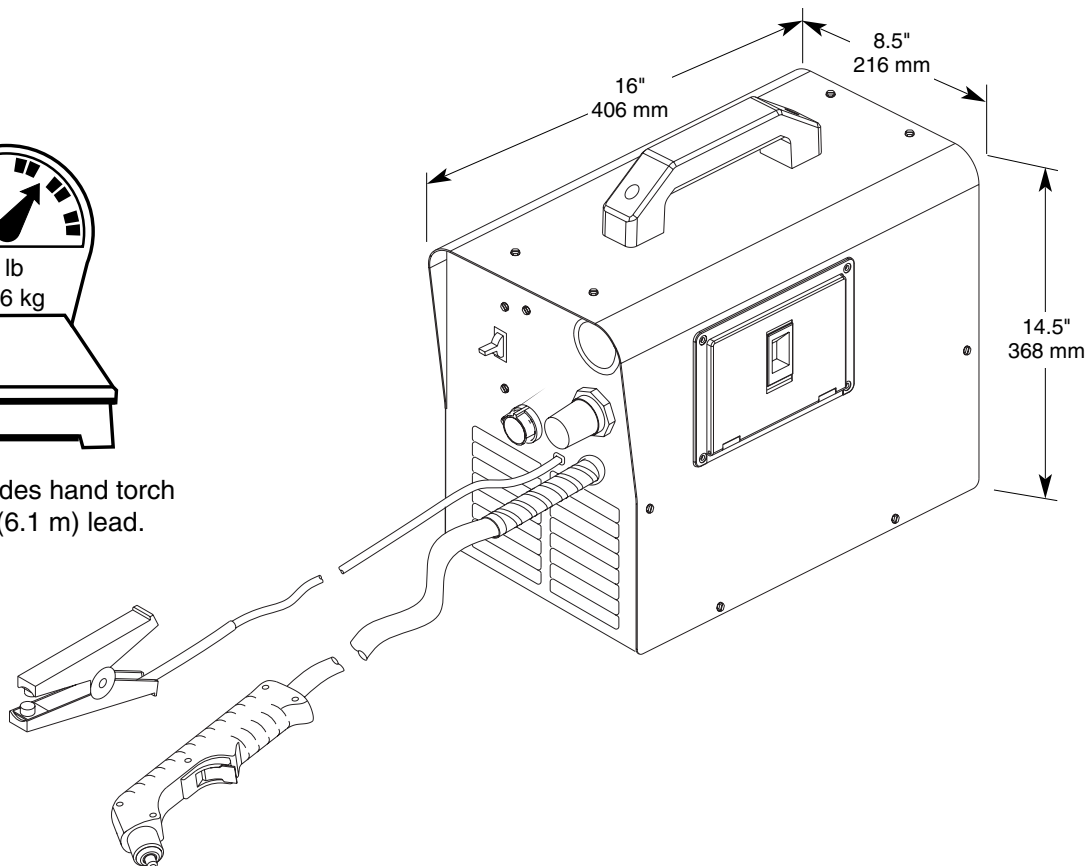

Specifications – PAC110T Torches

Recommended Cutting Capacity	1/4 inch (6 mm) @ 27A (35 % duty cycle)
Maximum Cutting Capacity	3/8 inch (10 mm) @ 27A (35 % duty cycle)
Severance Cutting Capacity	1/2 inch (12 mm) @ 27A (35 % duty cycle)
Gas Flow	270 scfh/4.5 scfm @ 60 psi (127 l/min @ 4.2 bar)
Weight	3 pounds (1.4 kg)

PAC110T Torch Dimensions

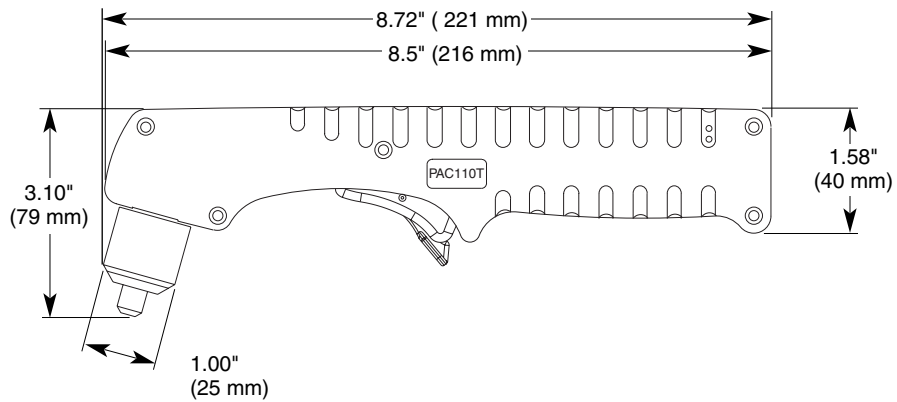











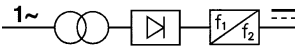



Symbols and Markings

S Mark

The **S** mark indicates that the power supply and torch are suitable for use in environments with increased hazard of electrical shock.

IEC Symbols Used

The following symbols may appear on the power supply data plate, control labels and switches.

	Direct Current (DC)		A chopper-based power source
	Alternating current (AC)		Plasma torch in the TEST position (cooling and cutting gas exiting nozzle)
	Plasma torch cutting		Power is ON
	AC input power connection		Power is OFF
	The terminal for the external protective (earth) conductor		Alternating current (AC)
	Light ON		Inlet gas pressure
	Light OFF		Consumables are loose or missing
	Light blinking		Power supply is over heated

Section 3

SETUP

In this section:

- Upon Receipt3-2
- Claims3-2
- Contents of Box.....3-2
- Locating Power Supply3-2
- 115/230 Voltage Configurations3-2
- Input Voltage Selector Switch3-3
- Power Cord Plugs3-4
- Grounding3-4
- Extension Cords.....3-5
- Work Cable and Clamp3-5
- Plasma Gas Supply3-6
 - Additional Gas Filtration3-6
- Gas Supply Connection3-7

Upon Receipt

1. Check that all items on your order have been received. Contact your distributor/OEM if any items are missing or damaged.
2. If there is evidence of damage, refer to *Claims*, below. All communications regarding this equipment must include the model number and serial number located on the back of the power supply.
3. Read the *Safety* section of this manual before setting up and operating this Hypertherm system.

Claims

Claims for damage during shipment: If your unit was damaged during shipment, you must file a claim with the carrier. Hypertherm will furnish you with a copy of the bill of lading upon request. If you need additional assistance, call the nearest Hypertherm office listed in the front of this manual.

Claims for defective or missing merchandise: If any component is missing or defective, contact your Hypertherm distributor/OEM. If you need additional assistance, call the nearest Hypertherm office listed in the front of this manual.

Contents of Box

Verify items against the illustration shown:

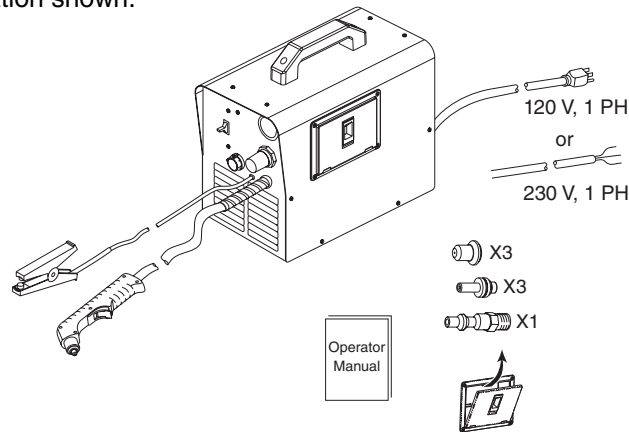

Locating Power Supply

Locate the Powermax380 power supply near the 115V or 230V power receptacle. Allow at least 10 inches (0.25 m) of space at the front and back of the power supply for proper ventilation.

115/230 Voltage Configurations

The 115/230V Powermax380 power supplies are shipped with the input voltage selector switch positioned as follows:

- 60 Hz Power Supply – 115 volts
- 50 Hz Power Supply – 230 volts





CAUTION **SYSTEM CIRCUIT REQUIREMENTS**

A circuit capable of 20A, 115V or 10A, 230V is required for proper operation. Protect circuit with appropriate size fuses or circuit breakers.

Input Voltage Selector Switch

The input voltage selector switch allows either 115V or 230V to be used as the Powermax380 input voltage. Set the required voltage as shown below:

CAUTION

Do not reposition Voltage Selector Switch with power ON. Damage to the power supply will result.

①

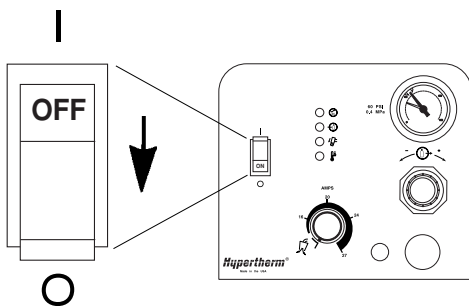

1. Turn power OFF

②

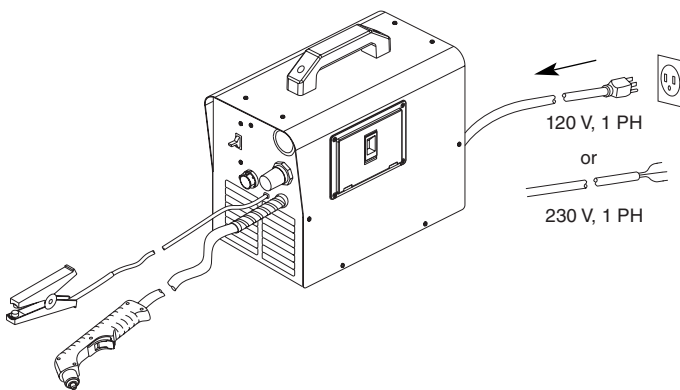

2. Remove power cord from power receptacle.

③

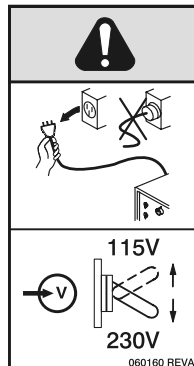
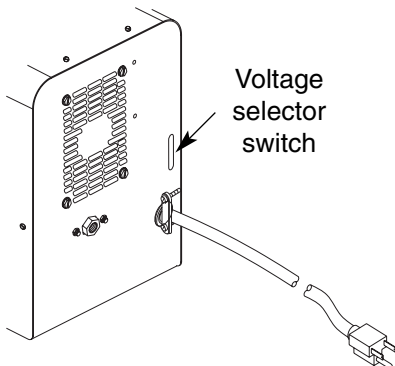

3. Set input voltage

- Determine correct switch position for the voltage required.
- Voltage selector switch is accessible through slot in rear panel.

Power Cord Plugs

The 115/230V Powermax380 power supplies are shipped with the following power cord configurations: the 60 Hz units are shipped with a 115V plug on the power cord; the 50 Hz units are shipped without a plug on the power cord. To operate at 230V, obtain a plug that meets national or local electrical codes. The plug should be connected to the power cord by a licensed electrician. Also, note that some 115V receptacles may require a plug that is different from the plug on the power cord. To install the required plug, refer to figure below. The installed 115V plug and cords must conform to national or local electrical codes.

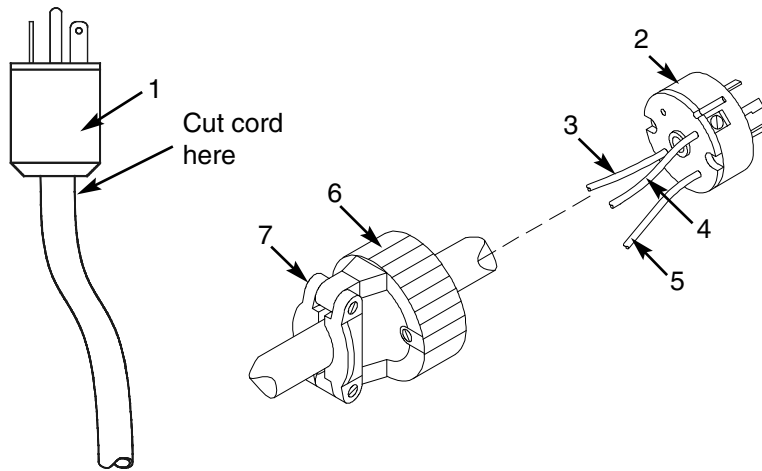

- 1 Power Cord plug (115V shown)
 - Cut cord close to plug.
- 2 230V plug
- 3 To load 1 terminal (brass)
- 4 To load 2 terminal (brass)
- 5 To ground terminal (green)
- 6 Outer shell
- 7 Cord grip

Remove cord insulation in order to separate conductors. Remove conductor insulation in order to make good contact with plug terminals. Make connections, reinstall outer shell and cord grip, and secure with screws.

Do not overtighten!

Grounding

To ensure personal safety, proper operation, and to reduce electromagnetic interference (EMI), the Powermax380 must be properly grounded through the power cord according to national or local electrical codes. Single-phase service must be of the 3-wire type with a green or green/yellow wire for protective earth ground and must comply with national or local electrical requirements. **Do not use a 2-wire service!** Refer to *Grounding*, in the Safety section.

Extension Cords

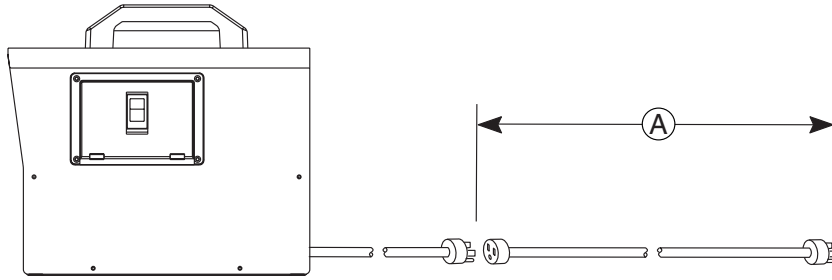

Use an extension cord of appropriate wire size for the cord length and system voltage. Use a cord that is certified by national or local codes. The cord should be installed by a licensed electrician.

Input-Voltage	Phase	A	
		Recommended Cord Gauge Size	Length
115 VAC	1	12 AWG	< 53 ft (16 m)
230 VAC	1	14 AWG	< 133 ft (41 m)

Work Cable and Clamp

The work clamp must be attached to the workpiece while cutting. Ensure that the work clamp and the workpiece make good metal-to-metal contact. Attach the work clamp as close as possible to the area being cut to reduce exposure to electric and magnetic fields (EMF). **Do not attach the work clamp to the portion of the workpiece to be cut away!**

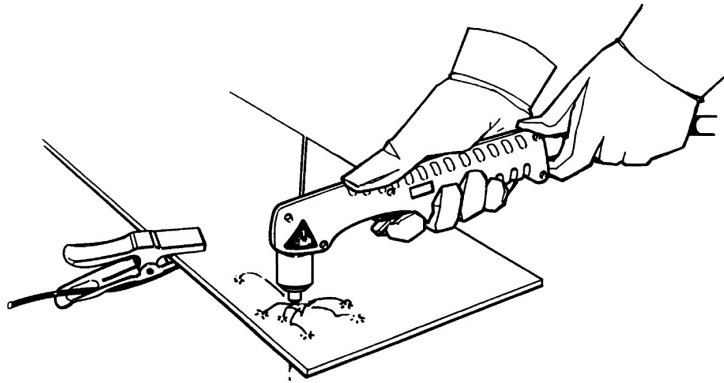

Plasma Gas Supply

The gas supply for the Powermax380 can be shop compressed air or cylinder compressed air. A high-pressure regulator must be used on either type of supply and must be capable of delivering gas to the filter on the power supply at **270 scfh/4.5 scfm (127 l/min)** at a pressure of **60 psi (4.2 bar)**. If gas supply quality is poor, cut speeds decrease, cut quality deteriorates, cutting thickness capability decreases, and parts life shortens.



WARNING



**Do not allow the air inlet pressure to the filter on the power supply exceed 120 psi (8.3 bar).
The filter bowl may explode if this pressure is exceeded.**

Additional Gas Filtration

Use a 3-stage coalescing filtration system, as shown, when site conditions introduce moisture, oil or other contaminants into the air line.

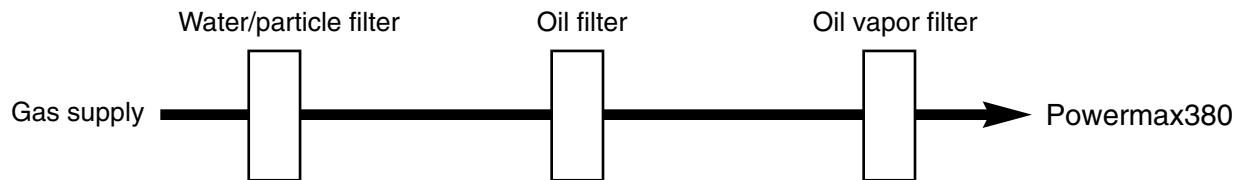

Gas Supply Connection

Connect the air hose as follows:

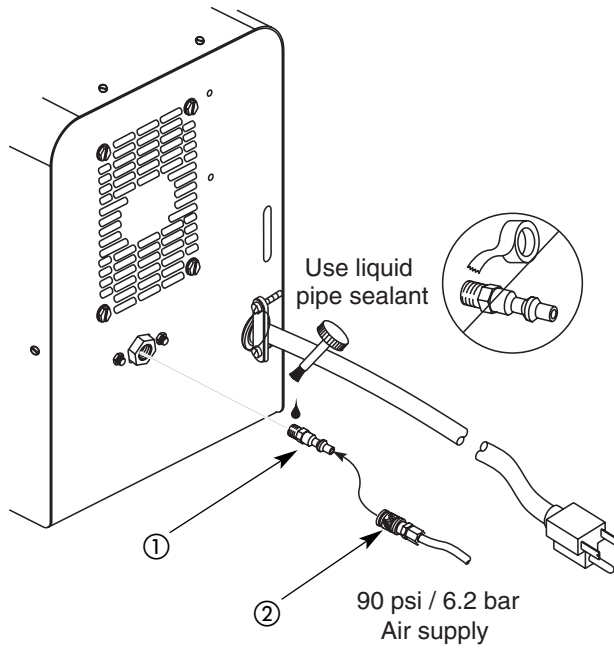

1. Air fitting

- Install 1/4 NPT quick-disconnect nipple on to air fitting. Use liquid pipe sealant.

CAUTION: Never use Teflon tape when installing the nipple or adapters. Bits of tape can break off and enter the air line and harm the pressure regulator, pressure switch and valve.

- Nipple is found in the consumables box, located on the left side of the power supply cover.

2. Air hose

- Use an inert gas hose with a 3/8 inch (9.5 mm) internal diameter and a 1/4 NPT quick-disconnect coupler. Connect it to the nipple installed in step 1.

Adjust the air pressure according to the procedure in Section 4.

Section 4

OPERATION

In this section:

Controls and Indicators	4-2
Installing Torch Consumables	4-3
Turn Power ON	4-4
Adjust Gas Pressure and Current Setting	4-4
Check Indicator LEDs	4-5
Hand Torch Operation	4-6

Controls and Indicators

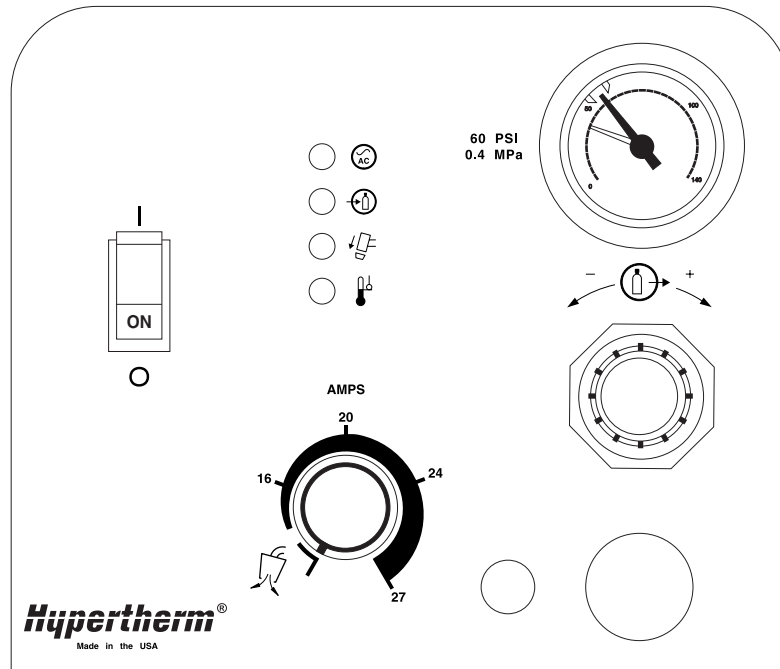

ON (I)/OFF (O) Power Switch

Activates the power supply and its control circuits.



Green POWER ON LED

When illuminated, indicates that the power switch has been set at I (ON) and that the safety interlocks are satisfied.



Yellow GAS PRESSURE LED

When illuminated, indicates that the gas pressure is below 40 psi (2.8 bar).



Yellow TORCH CAP LED

When illuminated, indicates that the torch consumables are loose or not installed.



Yellow TEMP LED

When illuminated, indicates that the power supply is out of its operating range.



AMPS-GAS TEST/SET Adjustment Knob

Adjusts output current between 14 and 27 amps. The  position allows adjustment of the air pressure.



Pressure Gauge



Indicates gas pressure at the power supply.



Pressure Regulator Adjustment Knob

Regulates gas pressure to the power supply.

Installing Torch Consumables

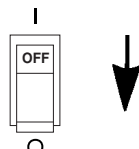
		<p align="center">WARNING INSTANT-ON TORCHES PLASMA ARC CAN CAUSE INJURY AND BURNS</p>
	<p>Plasma arc comes on immediately when the torch switch is activated. The plasma arc will quickly cut through gloves and skin. Make sure power is OFF before changing consumables.</p>	

①

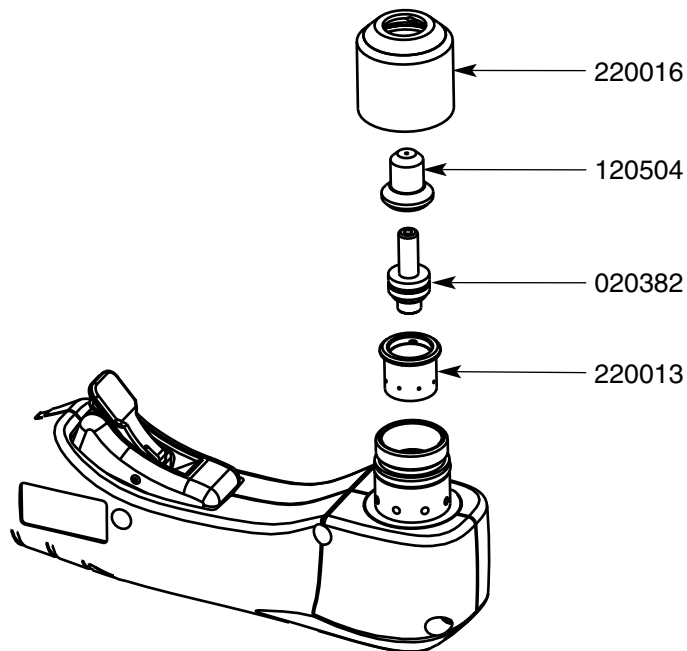

②

Hand tighten only.

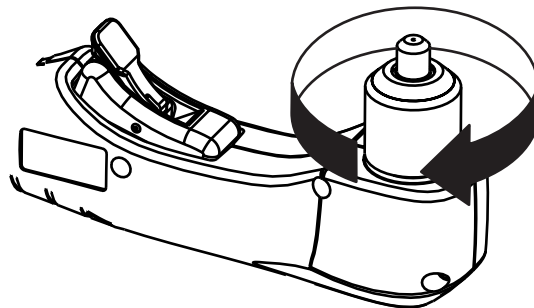

Turn Power ON

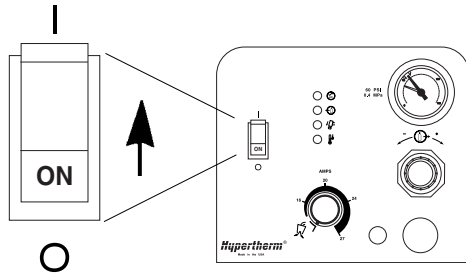

Adjust Gas Pressure and Current Setting

①

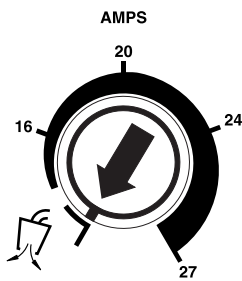

Set current knob to gas test.

②

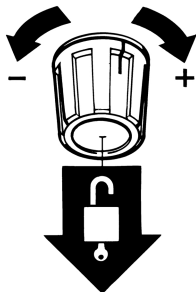

Pull regulator knob to unlock.

③

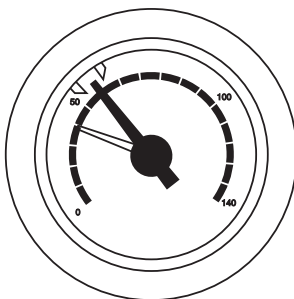

Set pressure to 60 psi (4.2 bar).

④

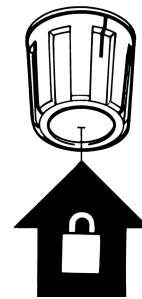

Push regulator knob to lock.



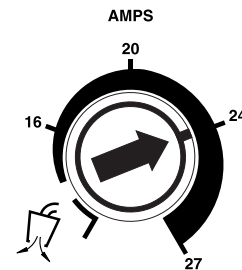

⑤



Turn current knob away from gas test to stop gas flow.

Check Indicator LEDs

System is ready when lights are as shown:

	Power ON / system ready
	Gas pressure
	Torch parts
	Temperature

See *Basic Troubleshooting*, Section 5 for additional information.

Hand Torch Operation



WARNING
INSTANT-ON TORCHES
PLASMA ARC CAN CAUSE INJURY AND BURNS

Plasma arc comes on immediately when the torch switch is activated.
The plasma arc will quickly cut through gloves and skin.

- Keep away from the torch tip.
- Do not hold the workpiece, and keep your hands clear of the cutting path.
- Never point the torch toward yourself or others.

Safety Trigger Operation

①

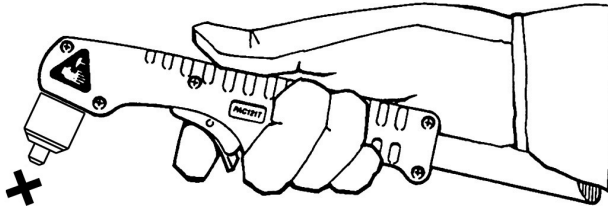

②

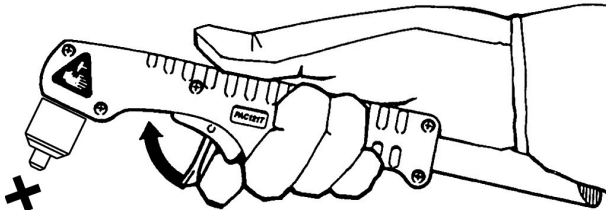

③

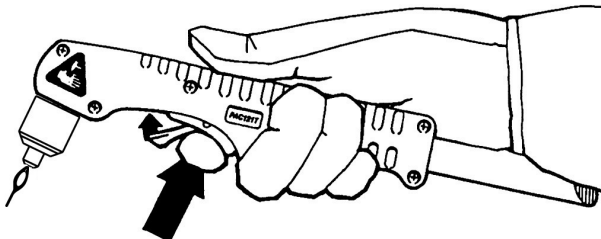

Avoid firing the torch when it is not in contact with the workpiece.

Hand Torch Cutting Technique

Maintain an approximate 1/16 inch / 1.5 mm torch-to-work distance.

When cutting, make sure that sparks are exiting from the bottom of the workpiece.

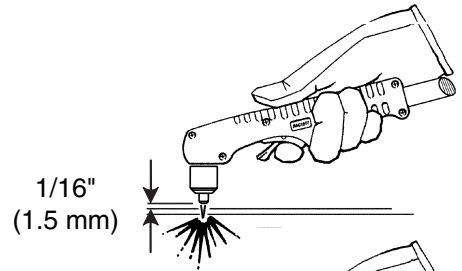

If sparks are spraying up from the workpiece, you are moving the torch too fast, or without sufficient power.

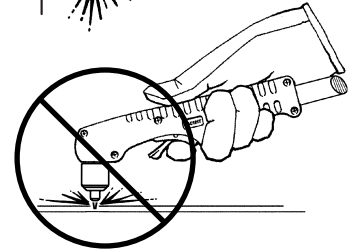

Hold the torch nozzle at a vertical position and watch the arc as it cuts along the line.

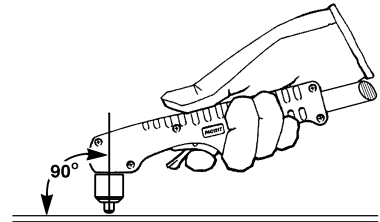

Firing the torch unnecessarily reduces nozzle and electrode life.

Pulling the torch through the cut is easier than pushing it.

To cut thin material, reduce the amps until you get the best quality cut.

For straight-line cuts, use a straight edge as a guide. To cut circles, use a template or a radius cutter attachment.



Starting a cut from the edge of the workpiece

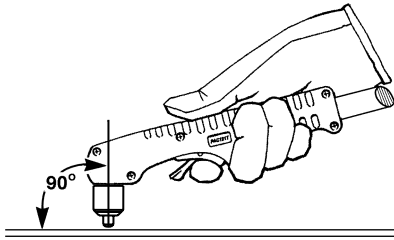
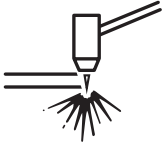

Hold the torch vertical at the edge of the workpiece.

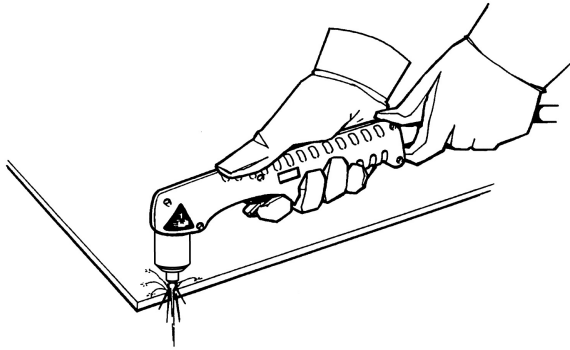

Start cut at the edge of the workpiece.

Pause at the edge until the arc has completely cut through the workpiece.

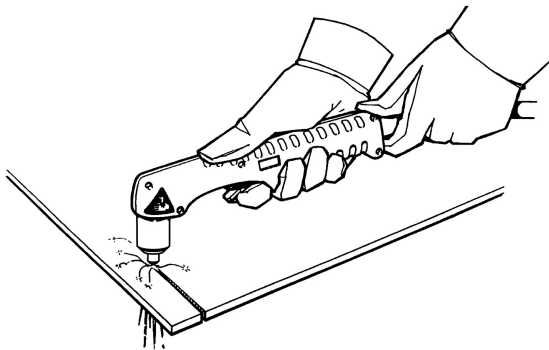

Then, proceed with the cut.

Piercing

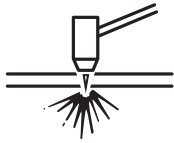

		<p>WARNING SPARKS AND HOT METAL CAN INJURE EYES AND BURN SKIN</p>
<p>When firing the torch at an angle, sparks and hot metal will spray out from the nozzle. Point the torch away from yourself and others.</p>		

Hold the torch so that the nozzle is within 1/16 inch / 1.5 mm from the workpiece before firing the torch.

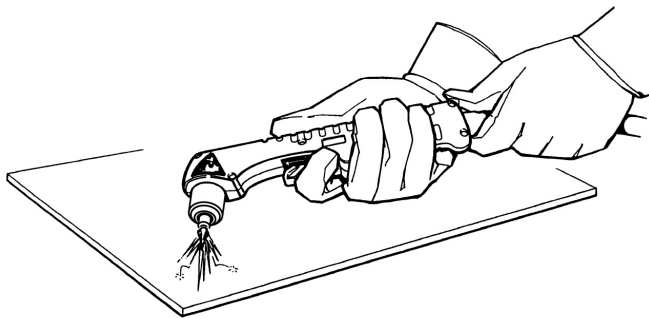

Fire the torch at an angle to the workpiece, then slowly rotate it to an upright position.

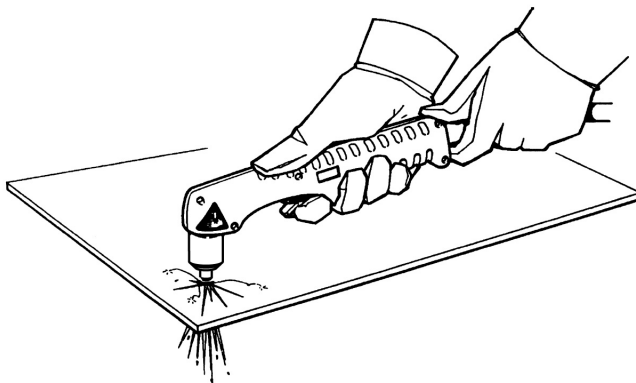

When sparks are exiting from the bottom of the workpiece, the arc has pierced through the material.

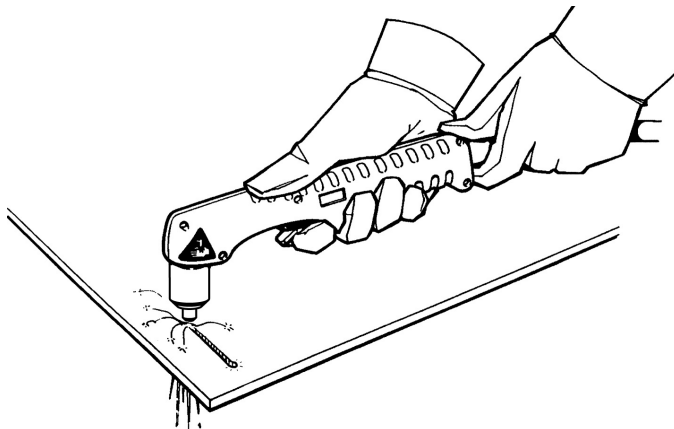

When the pierce is complete, proceed with the cut.

Torch Operation

Cut Chart - 27 Amp Standard Consumables

- Torch-to-work distance for the following cut chart is 1/16 inch / 1.5 mm for all cuts.

Retaining Cap
220016

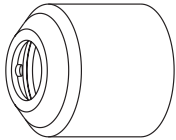

Nozzle
120504



Electrode
020382

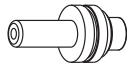

Swirl Ring
220013

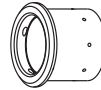

PAC110T
Torch



Material Thickness		Material	Arc Current (A)	Recommended Travel Speed	
(ga. or in.)	(mm)			(ipm)	(mm/min.)
18 ga.	1.3	Mild Steel	27	160	4060
10 ga.	3.4	Mild Steel	27	57	1460
1/4"	6.0	Mild Steel	27	18	465
3/8"	9.0	Mild Steel	27	12	325
18 ga.	1.3	Stainless Steel	27	156	3960
10 ga.	3.4	Stainless Steel	27	45	1150
1/4"	6.0	Stainless Steel	27	16	400
3/8"	9.0	Stainless Steel	27	8	220
18 ga.	1.3	Aluminum	27	192	4875
10 ga.	3.4	Aluminum	27	51	1300
1/4"	6.0	Aluminum	27	13	345
3/8"	9.0	Aluminum	27	8	200

† To cut material above 6 mm, start torch at edge of material.









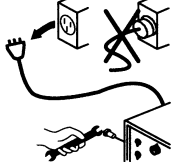

Section 5

MAINTENANCE AND PARTS

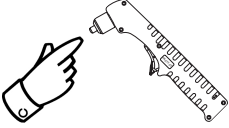

In this section:

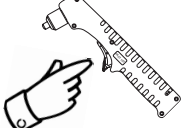
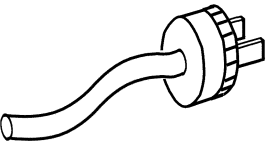
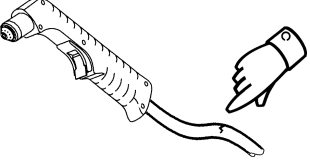
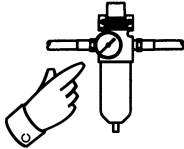
Routine Maintenance	5-2
Inspect Consumables.....	5-3
Controls and Indicators	5-4
Basic Troubleshooting.....	5-5
Technical Questions	5-7
Parts	5-8
Torch Consumables.....	See Section 4
PAC110T Hand – Torch Assembly.....	5-9
Power Supply – Filter Regulator.....	5-10
Power Supply – Work Cable.....	5-10
Powermax380 Labels	5-11

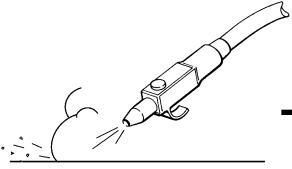
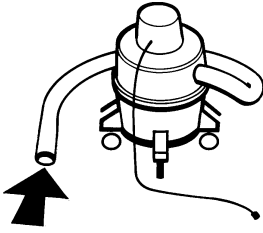
Routine Maintenance

		<p>WARNING ELECTRIC SHOCK CAN KILL</p>
	<p>Disconnect electrical power before performing any maintenance. All work requiring removal of the power supply cover must be performed by a qualified technician.</p>	
 Each Use	 Check gas pressure.	 Check consumables for wear and proper installation.
 Each Week		Check torch cap-on safety switch: listen for "click" when the retaining cap is loosened.
 3 Months	 Replace damaged labels.	 Check trigger for damage. Check torch body for cracks or exposed wires.
 Replace damaged power cord or plug.	 Replace damaged torch lead.	 Check pressure hose and connections for leaks.
 6 Months		 Clean the inside of the power supply with air pressure or vacuum.

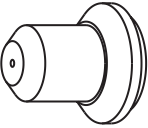
Inspect Consumables

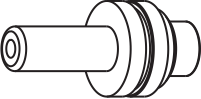
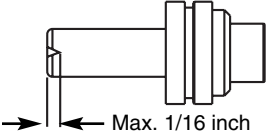
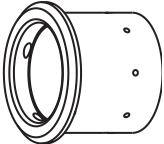
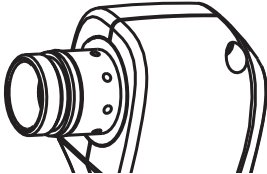
<i>Part</i>	<i>Check For</i>	<i>Action</i>
 Nozzle Center hole	Roundness of through hole  Good Worn	Replace
 Electrode Center surface	 Maximum pit depth 1/16 inch (1.6 mm)	Replace
 Swirl Ring External surfaces Gas holes	Damage or debris Blocked holes	Replace Replace
 Torch O-ring External surfaces	Damage or wear Lubricated	Replace Apply a thin film of silicone lubricant

Controls and Indicators

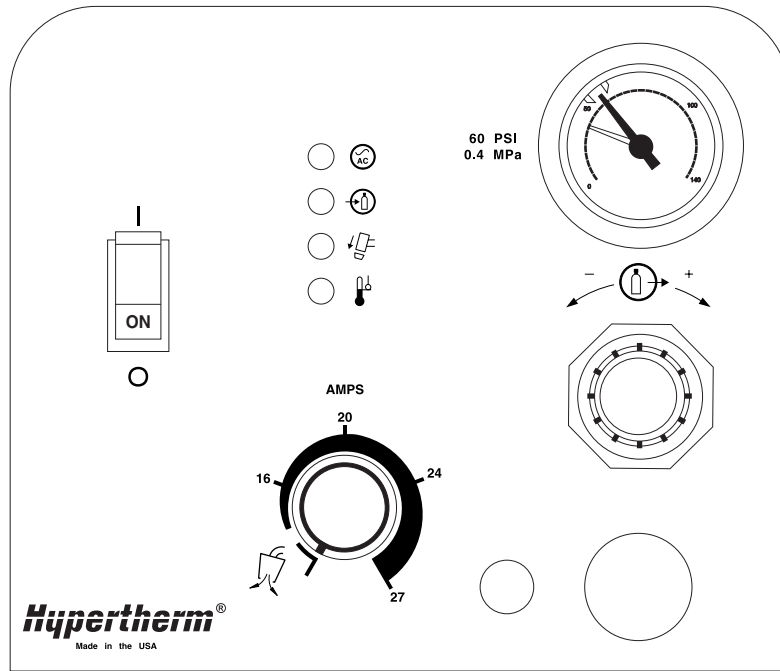

ON (I)/OFF (0) Power Switch

Activates the power supply and its control circuits.



Green POWER ON LED

When illuminated, indicates that the power switch has been set at I (ON) and that the safety interlocks are satisfied.



Yellow GAS PRESSURE LED

When illuminated, indicates that the gas pressure is below 40 psi (2.8 bar).



Yellow TORCH CAP LED

When illuminated, indicates that the torch consumables are loose or not installed.



Yellow TEMP LED

When illuminated, indicates that the power supply is out of its operating range.



AMPS-GAS TEST/SET Adjustment Knob

Adjusts output current between 14 and 27 amps. The  position allows adjustment of the air pressure.



Pressure Gauge

Indicates gas pressure at the power supply.



Pressure Regulator Adjustment Knob

Regulates gas pressure to the power supply.

Basic Troubleshooting

Problem

1. The ON/OFF power switch is set to I (ON), but the fan does not operate and the POWER ON LED is not illuminated.

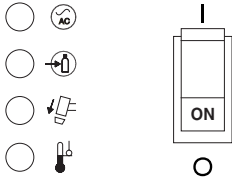

Cause / Solution

- 1.1 The power cord is not plugged into the power receptacle.**
Plug the power cord into the receptacle.
- 1.2 The disconnect power switch is not set to ON or there is no power available to the disconnect power switch box.**
Turn on the power at the main power panel or at the disconnect power switch box.
- 1.3 The safety interlock is activated.**
If the power supply is turned on while the torch trigger is pressed the torch will be disabled. To clear fault, release the torch.
- 1.4 The voltage selector is not set to the correct position.**
If the voltage selector switch position is not set to match the input voltage the POWER ON LED will not illuminate, the torch will be disabled, and the fan will rotate slowly. To clear this fault see *Input Voltage Selector Switch*, Section 3.

2. All four of the LEDs are blinking.

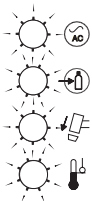

- 2.1 Micro-processor fault.**

Check to see if welding High Frequency (HF) is being used near the Powermax380 power supply. Turn OFF the welding HF if it exists. Turn the PMX380 OFF and then ON. If the problem persists see *Technical Questions* in this section.

3. The POWER ON LED is blinking.

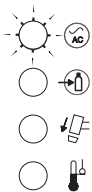

- 3.1 Line voltage is either too low or too high.**

The following table lists the operating range of the Powermax380 power supply. Have an electrical technician check incoming power.

Note: Input voltage should be within 20% of the specified system line voltage.

Lower Limit	System Line Voltage	Upper Limit
92 VAC	115 VAC	138 VAC
184 VAC	230 VAC	276 VAC

Basic Troubleshooting (continued)

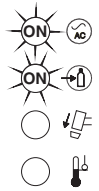
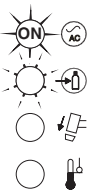
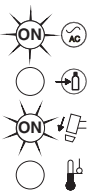
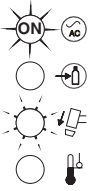
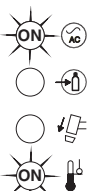
Problem	Cause / Solution
<p>4. The POWER ON LED is illuminated and the GAS PRESSURE LED is illuminated.</p> 	<p>4.1 <i>The gas supply is not connected to the power supply or is turned.</i> Check that the gas is connected to the power supply and turned on.</p> <p>4.2 <i>The incoming gas pressure is too low.</i> Set incoming gas pressure to 90–120 psi (6.2–8.3 bar). Check that there are no leaks in the gas supply line.</p>
<p>5. The POWER ON LED is illuminated and the GAS PRESSURE LED is blinking.</p> 	<p>5.1 <i>The gas supply was interrupted.</i> If the gas pressure drops below 40 psi after the torch trigger is pressed the GAS PRESSURE LED will blink. Check the torch lead and air hose from the gas supply for pinched hoses or obstructions. Check that the gas pressure has been set correctly. See <i>Plasma Gas Supply</i>, Section 3.</p>
<p>6. The POWER ON LED is illuminated and the TORCH CAP LED is illuminated.</p> 	<p>6.1 <i>Torch consumables are loose or removed from the torch.</i> Turn power supply OFF and tighten or install torch consumables. See <i>Installing Torch Consumables</i>, Section 4.</p> <p>If the torch consumables are loose or are removed while the power supply is ON, turn OFF the power supply, tighten the consumables and then turn the power supply ON to clear this fault.</p>
<p>7. The POWER ON LED is illuminated and the TORCH CAP LED is blinking.</p> 	<p>7.1 <i>Pilot arc "misfires" or circuit was not completed.</i> If the electrode is excessively worn when the the torch trigger is pressed, the gas flows but the pilot arc will not start. Inspect and change the consumables as necessary. Also inspect the torch lead for damage. After the problem has been corrected pull the trigger to reset the blinking LED. See <i>Inspect Consumables</i>, in this section.</p>
<p>8. The POWER ON LED is illuminated and the TEMP LED is illuminated.</p> 	<p>8.1 <i>Power supply is too hot.</i> Leave the power supply ON, for 15 minutes or until TEMP LED is extinguished, to allow the fan to cool the power supply. Reduce amperage or duty cycle before cutting.</p> <p>8.2 <i>Power supply is too cold.</i> If the ambient temperature is below -31° F (-35° C) the TEMP LED will light. Move the power supply to a warmer location.</p>

Basic Troubleshooting (continued)

Problem	<i>Cause</i> / Solution
9. The arc does not transfer to the workpiece.	<p>9.1 <i>The work clamp is not connected to the workpiece or the work cable is damaged.</i> Connect or repair the work clamp or cable.</p> <p>9.2 <i>The work clamp is not making good metal-to-metal contact.</i> Clean the area where the clamp contacts the workpiece.</p> <p>9.3 <i>The torch is too far away from the workpiece.</i> Move the torch head closer to the workpiece and start the torch again. See <i>Torch Operation</i>, Section 4.</p>
10. The arc blows out, but re-ignites when the torch switch is depressed again.	<p>10.1 <i>The consumable parts are worn or damaged.</i> Inspect and change the consumables, as necessary. See <i>Inspect Consumables</i>, in this section. See <i>Torch Operation</i>, Section 4.</p> <p>10.2 <i>The gas pressure is incorrect.</i> Adjust the operating gas pressure. See <i>Check and Adjust Gas Pressure</i>, Section 4. Check that the gas pressure to the power supply is not less than 90 psi (6.2 bar) at a flow of 6 scfm (170 l/m).</p> <p>10.3 <i>The gas filter element inside the power supply is contaminated.</i> Replace filter element. See <i>Air Filter Element Replacement</i>, in this section.</p>
11. The arc sputters and hisses.	<p>11.1 <i>The gas filter element inside the power supply is contaminated.</i> Replace filter element. See <i>Air Filter Element Replacement</i>, in this section.</p> <p>11.2 <i>There is water in the air line.</i> Install or repair air filtration to power supply. See <i>Additional Gas Filtration</i>, Section 3.</p>
12. Cut quality is not good.	<p>12.1 <i>Consumables are worn or the torch is being used incorrectly .</i> See <i>Inspect Consumables</i>, in this section. See <i>Hand Torch Operation</i>, Section 4.</p>

Technical Questions

If you are unable to fix the problem by following this basic troubleshooting guide or if you need further assistance:

1. Call your Hypertherm distributor or authorized Hypertherm repair facility.
2. Call the nearest Hypertherm office listed in the front of this manual.
3. See the Powermax380 Service Manual for wiring diagrams, higher-level troubleshooting and more parts list information.

Parts

PAC110T Hand Torch Assembly

Item	Part Number	Description	Quantity
	070071*	PAC110T Hand Torch Assembly with 20 ft (6.1 m) Lead	
1	001288	Handle, 2 Sides	1
2	002244	Safety Trigger	1
3	128377	Replacement Start Switch (switch and wire splices)	1
4	027254	Trigger Spring	1
5	004764	Gutcha Retaining Ring	1
6	075339	Screws, P/S, # 4 X 1/2, PH, RND, S/B	5
7	120976	Torch Main Body with Safety Switch	1
8	058503	O-Ring: Viton .625 X .070	1
9	128554	Replacement 20 ft (6.1 m) Torch Lead	1
* Top assembly includes the following consumables (See page 4-3 for details of consumable parts):			
	020382	Electrode	1
	220013	Swirl Ring	1
	220016	Retaining Cap	1
	120504	Nozzle	1

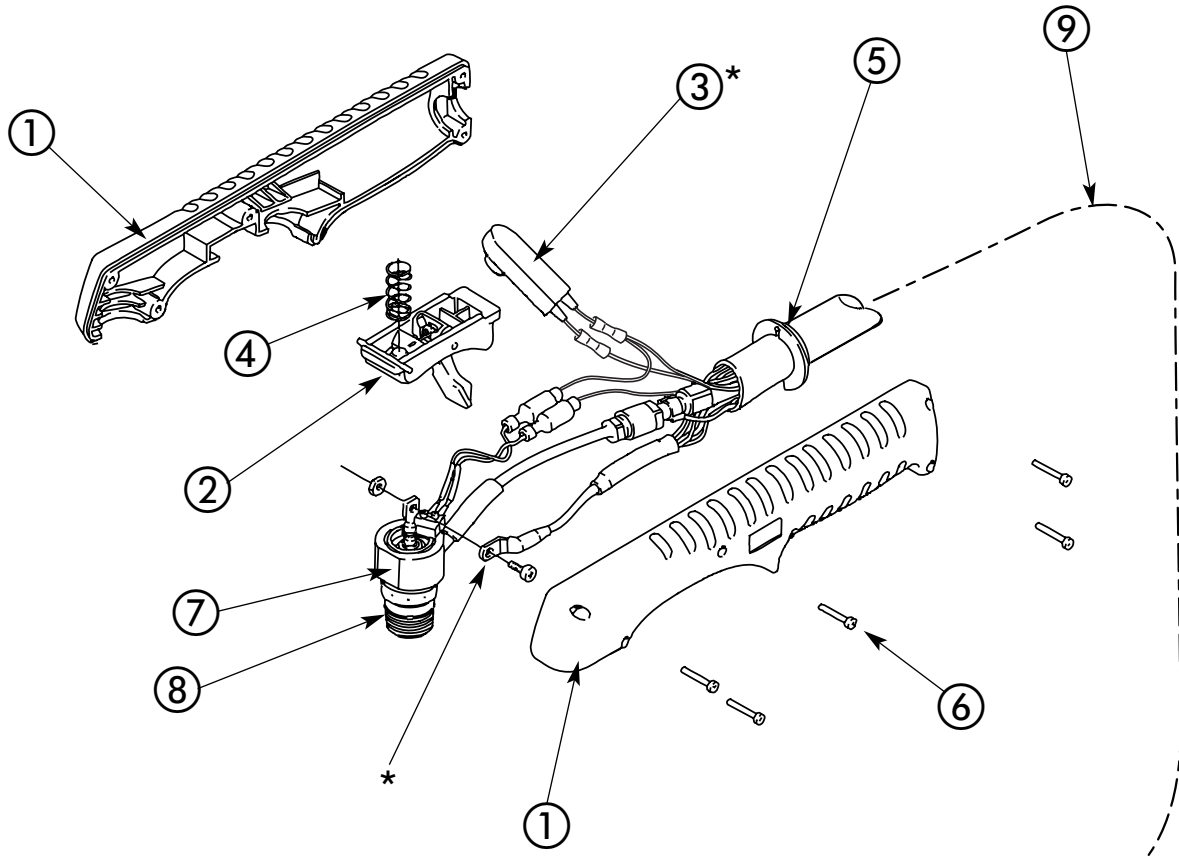

* Included with replacement assembly.

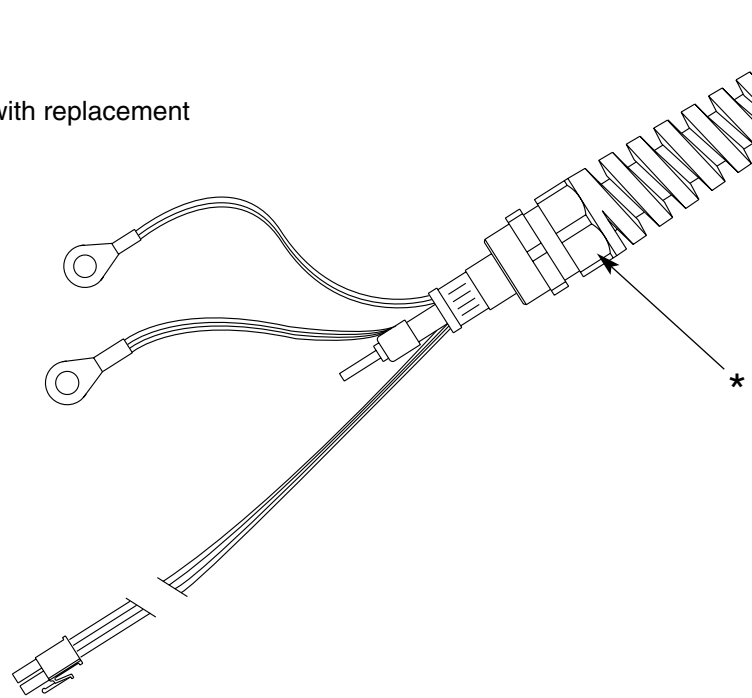

Power Supply – Filter Regulator

Item	Part Number	Description	Qty.
1	060197	Air filter element	1
2	060203	O-ring	1

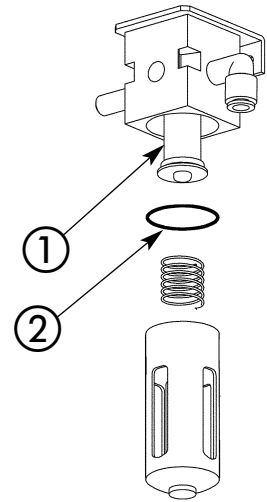

Power Supply – Work Cable

Item	Part Number	Description	Qty.
1	060009	Work Cable with clamp, 15 ft (4.6 m)	1

